

**FLUKE**®

# **789/787B**

ProcessMeter™

## Users Manual

August 2002, Rev. 4, 1/17

© 2002-2017 Fluke Corporation. All rights reserved. Specifications are subject to change without notice.  
All product names are trademarks of their respective companies.

### **LIMITED WARRANTY AND LIMITATION OF LIABILITY**

This Fluke product will be free from defects in material and workmanship for three years from the date of purchase. This warranty does not cover fuses, disposable batteries, or damage from accident, neglect, misuse, alteration, contamination, or abnormal conditions of operation or handling. Resellers are not authorized to extend any other warranty on Fluke's behalf. To obtain service during the warranty period, contact your nearest Fluke authorized service center to obtain return authorization information, then send the product to that Service Center with a description of the problem.

THIS WARRANTY IS YOUR ONLY REMEDY. NO OTHER WARRANTIES, SUCH AS FITNESS FOR A PARTICULAR PURPOSE, ARE EXPRESSED OR IMPLIED. FLUKE IS NOT LIABLE FOR ANY SPECIAL, INDIRECT, INCIDENTAL OR CONSEQUENTIAL DAMAGES OR LOSSES, ARISING FROM ANY CAUSE OR THEORY. Since some states or countries do not allow the exclusion or limitation of an implied warranty or of incidental or consequential damages, this limitation of liability may not apply to you.

Fluke Corporation  
P.O. Box 9090  
Everett, WA 98206-9090  
U.S.A.

Fluke Europe B.V.  
P.O. Box 1186  
5602 BD Eindhoven  
The Netherlands

# Table of Contents

Title	Page
Introduction .....	1
How to Contact Fluke .....	2
Safety Information .....	2
How to Get Started.....	6
Getting Acquainted with the Meter .....	7
Measuring Electrical Parameters.....	18
Input Impedance.....	18
Ranges .....	18
Testing Diodes.....	18
Displaying Minimum, Maximum, and Average.....	19
Using AutoHold.....	19
Compensating for Test Lead Resistance.....	20
Using the Current Output Functions .....	20
Source Mode .....	20
Simulate Mode.....	22
Producing a Steady mA Output .....	24
Manually Stepping the mA Output .....	25
Auto Ramping the mA Output.....	26

Power-Up Options .....	26
Loop Power Supply Mode (789 only) .....	28
Battery Life.....	30
Maintenance .....	30
Calibration.....	31
Replacing the Batteries .....	31
Replacing a Fuse .....	33
If the Meter does not Work.....	34
Replacement Parts and Accessories .....	34
Specifications.....	38

# ProcessMeter™

## Introduction

### Warning

**Read “Safety Information” before using the meter.**

The Fluke 789/787B ProcessMeter™ (the Meter or Product) is a handheld, battery-operated tool for measuring electrical parameters and supplying steady or ramping current to test process instruments. All illustrations in this manual show the 789 model.

The 789 adds a 24 V loop power supply. It has all the features of a digital multimeter, plus current output capability.

If the meter is damaged or something is missing, contact the place of purchase immediately. Contact a Fluke distributor for information about DMM (digital multimeter) accessories. To order replacement parts or spares, see Table 13 near the end of this manual.

## **How to Contact Fluke**

To contact Fluke, call one of the following telephone numbers:

- Technical Support USA: 1-800-44-FLUKE (1-800-443-5853)
- Calibration/Repair USA: 1-888-99-FLUKE (1-888-993-5853)
- Canada: 1-800-36-FLUKE (1-800-363-5853)
- Europe: +31 402-675-200
- Japan: +81-3-6714-3114
- Singapore: +65-6799-5566
- Anywhere in the world: +1-425-446-5500

Or, visit Fluke's website at [www.fluke.com](http://www.fluke.com).

To register your product, visit <http://register.fluke.com>.

To view, print, or download the latest manual supplement, visit <http://us.fluke.com/usen/support/manuals>.

## **Safety Information**

A **Warning** identifies conditions and procedures that are dangerous to the user. A **Caution** identifies conditions and procedures that can cause damage to the Product or the equipment under test.

International symbols used on the meter and in this manual are explained in Table 1.

### **⚠⚠ Warning**

**To prevent possible electrical shock, fire, or personal injury:**















- **Read all safety information before you use the Product.**
- **Carefully read all instructions.**
- **Do not alter the Product and use only as specified, or the protection supplied by the Product can be compromised.**
- **Remove the batteries if the Product is not used for an extended period of time, or if stored in temperatures above 50 °C. If the batteries are not removed, battery leakage can damage the Product.**

- The battery door must be closed and locked before you operate the Product.
- Replace the batteries when the low battery indicator shows to prevent incorrect measurements.
- Comply with local and national safety codes. Use personal protective equipment (approved rubber gloves, face protection, and flame-resistant clothes) to prevent shock and arc blast injury where hazardous live conductors are exposed.
- Do not apply more than the rated voltage, between the terminals or between each terminal and earth ground.
- Do not work alone.
- Limit operation to the specified measurement category, voltage, or amperage ratings.
- Use Product-approved measurement category (CAT), voltage, and amperage rated accessories (probes, test leads, and adapters) for all measurements.
- Measure a known voltage first to make sure that the Product operates correctly.
- Use the correct terminals, function, and range for measurements.
- Do not touch voltages > 30 V ac rms, 42 V ac peak, or 60 V dc.
- Do not use the Product around explosive gas, vapor, or in damp or wet environments.
- Do not use the Product if it operates incorrectly.
- Examine the case before you use the Product. Look for cracks or missing plastic. Carefully look at the insulation around the terminals.
- Do not use test leads if they are damaged. Examine the test leads for damaged insulation, exposed metal, or if the wear indicator shows. Check test lead continuity.

- **Keep fingers behind the finger guards on the probes.**
- **Only use probes, test leads, and accessories that have the same measurement category, voltage, and amperage ratings as the Product.**
- **Remove all probes, test leads, and accessories before the battery door is opened.**
- **Remove all probes, test leads, and accessories that are not necessary for the measurement.**
- **Do not exceed the Measurement Category (CAT) rating of the lowest rated individual component of a Product, probe, or accessory.**
- **Do not use test leads if they are damaged. Examine the test leads for damaged insulation and measure a known voltage.**
- **Do not use a current measurement as an indication that a circuit is safe to touch. A voltage measurement is necessary to know if a circuit is hazardous.**
- **Do not use the Product if it is altered or damaged.**
- **Do not use in CAT III or CAT IV environments without the protective cap installed on test probe. The protective cap decreases the exposed probe metal to <4 mm. This decreases the possibility of arc flash from short circuits.**



**Table 1. International Symbols**

Symbol	Description	Symbol	Description
	WARNING. RISK OF DANGER.		WARNING. HAZARDOUS VOLTAGE. Risk of electric shock.
	Consult user documentation.		Conforms to relevant South Korean EMC Standards
	Conforms to European Union directives	<b>IR</b>	Minimum fuse interrupt rating.
	Certified by CSA Group to North American safety standards.		Conforms to relevant Australian Safety and EMC standards.
	AC (Alternating Current)		Earth
	DC (Direct Current)		Fuse
	Battery		Double Insulated
<b>CAT II</b>	Measurement Category II is applicable to test and measuring circuits connected directly to utilization points (socket outlets and similar points) of the low-voltage MAINS installation.		
<b>CAT III</b>	Measurement Category III is applicable to test and measuring circuits connected to the distribution part of the building's low-voltage MAINS installation.		
<b>CAT IV</b>	Measurement Category IV is applicable to test and measuring circuits connected at the source of the building's low-voltage MAINS installation.		
	This product complies with the WEEE Directive marking requirements. The affixed label indicates that you must not discard this electrical/electronic product in domestic household waste. Product Category: With reference to the equipment types in the WEEE Directive Annex I, this product is classed as category 9 "Monitoring and Control Instrumentation" product. Do not dispose of this product as unsorted municipal waste.		

## How to Get Started

### Warning

To prevent possible electrical shock, fire, or personal injury:

- **Disconnect power and discharge all high-voltage capacitors before you measure resistance, continuity, capacitance, or a diode junction.**
- **Remove circuit power before you connect the Product in the circuit when you measure current. Connect the Product in series with the circuit.**
- **Do not use the HOLD function to measure unknown potentials. When HOLD is turned on, the display does not change when a different potential is measured.**

If familiar with the Fluke 80 Series DMM, read “Using the Current Output Functions,” review the tables and figures in “Getting Acquainted with the Meter,” and begin using the meter.

If unfamiliar with Fluke 80 Series DMMs, or DMMs in general, read “Measuring Electrical Parameters” in addition to the sections referenced in the previous paragraph.

The sections following “Using the Current Output Functions” contain information about the power-up options, and battery and fuse replacement instructions.

See Table 2 for an overview of the meter.

**Table 2. 789/787B ProcessMeter**

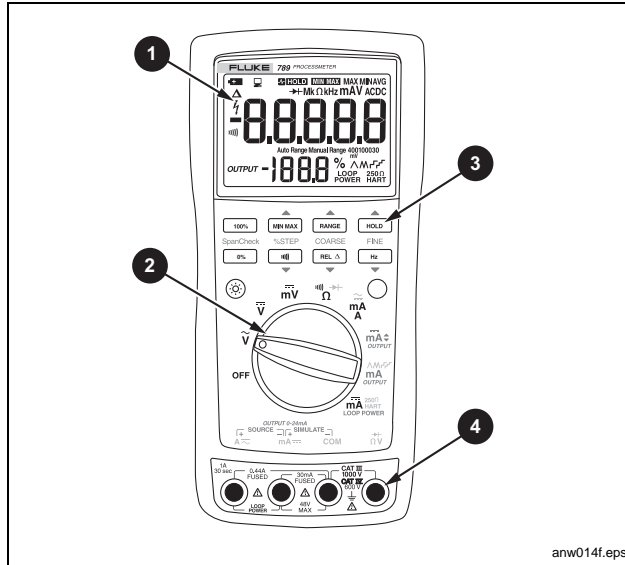

anw014f.eps

Item	Description
1	Display
2	Rotary switch
3	Pushbuttons
4	Input/Output jacks

## Getting Acquainted with the Meter

To become familiar with the features and functions of the meter, study these tables:

- Table 3 describes the input/output jacks.
- Table 4 describes the input functions of the first six rotary function switch positions.
- Table 5 describes the output functions of the last three rotary function switch positions.
- Table 6 describes the functions of the pushbuttons.
- Table 7 explains what all the elements of the display indicate.

**Table 3. Input/Output Jacks**

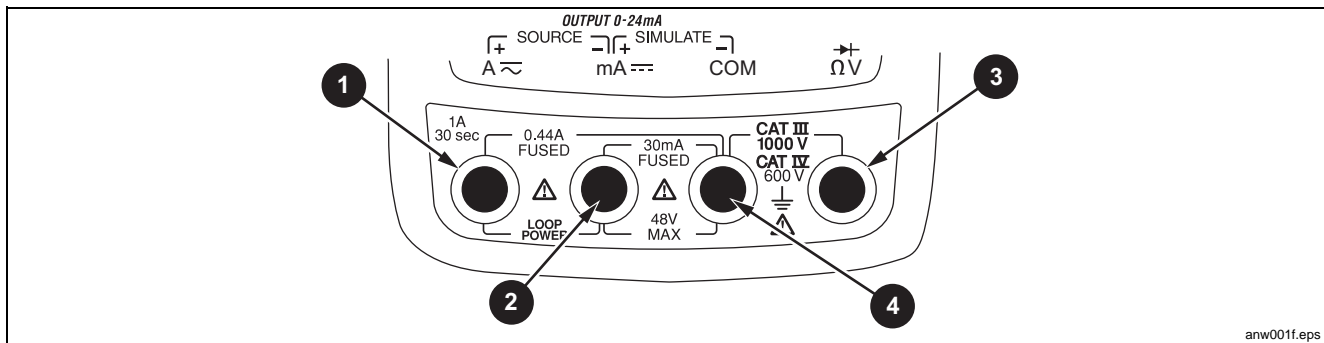

anw001f.eps

Item	Jack	Measurement Functions	Source Current Function	Simulate Transmitter Function
1	A ~	Input for current to 440 mA continuous. (1 A for up to 30 seconds.) Fused with a 440 mA fuse.	Output for dc current to 24 mA. Output for loop power supply (789 only).	
2	mA ===	Input for current to 30 mA. Fused with a 440 mA fuse.	Common for dc current output to 24 mA. Common for loop power supply.	Output for transmitter simulation to 24 mA. (Use in series with an external loop supply.)
3	ΩV	Input for voltage to 1000 V, Ω, continuity, and diode test.		
4	COM	Common for all measurements.		Common for transmitter simulation to 24 mA. (Use in series with an external loop supply.)

**Table 4. Rotary Function Switch Positions for Measurements**

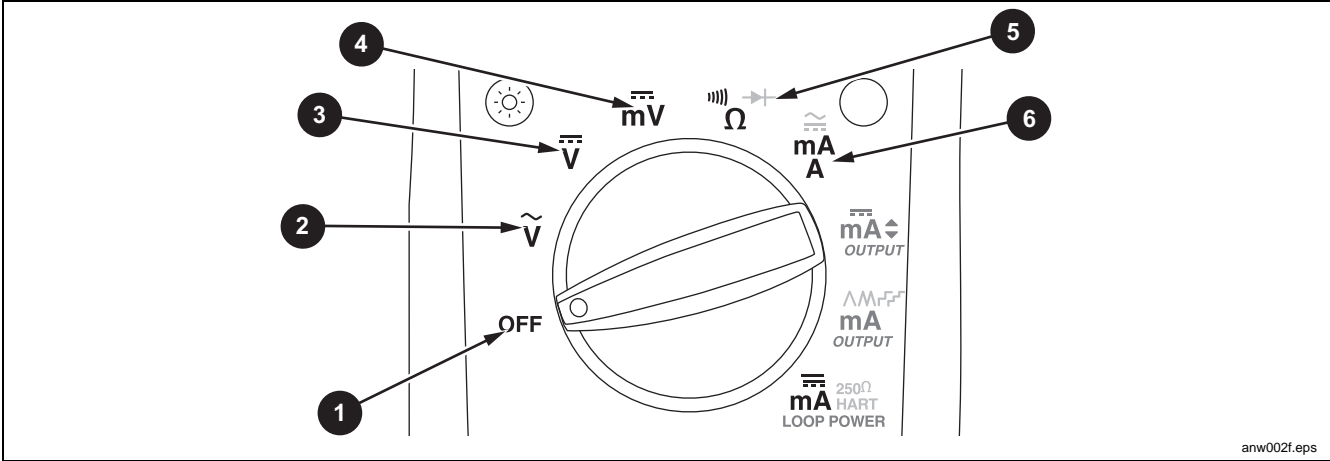

anw002f.eps

No.	Position	Function(s)	Pushbutton Actions
<b>1</b>	<b>OFF</b>	Meter off	
<b>2</b>	$\tilde{V}$	Default: Measure ac V <div style="border: 1px solid black; padding: 2px; display: inline-block; margin: 5px;">Hz</div> Frequency counter	<div style="display: flex; flex-direction: column; gap: 5px;"> <div style="display: flex; align-items: center;"> <div style="border: 1px solid black; padding: 2px; margin-right: 5px;">MIN MAX</div> <span>Selects a MIN, MAX, or AVG action</span> </div> <div style="display: flex; align-items: center;"> <div style="border: 1px solid black; padding: 2px; margin-right: 5px;">RANGE</div> <span>Selects a fixed range (hold 1 second for auto range)</span> </div> <div style="display: flex; align-items: center;"> <div style="border: 1px solid black; padding: 2px; margin-right: 5px;">HOLD</div> <span>Toggles AutoHold</span> </div> <div style="display: flex; align-items: center;"> <div style="border: 1px solid black; padding: 2px; margin-right: 5px;">REL Δ</div> <span>Toggles relative reading (sets a relative zero point)</span> </div> </div>

**Table 4. Rotary Function Switch Positions for Measurements (cont.)**

No.	Position	Function(s)	Pushbutton Actions
3	$\overline{\text{V}}$	Default: Measure dc V <input type="button" value="Hz"/> Frequency counter	Same as above
4	$\overline{\text{mV}}$	Default: Measure dc mV <input type="button" value="Hz"/> Frequency counter	Same as above (mV has only one range)
5	$\text{   } \rightarrow \text{+}$ $\Omega$	Default: Measure $\Omega$ <input type="button" value="   "/> for continuity <input type="radio"/> (Blue) $\rightarrow \text{+}$ test	Same as above (diode test has only one range)
6	$\approx$ $\overline{\text{mA}}$ A	<i>High test lead in <math>\sim</math> A:</i> Measure A dc <input type="radio"/> (Blue) selects ac <i>High test lead in <math>\overline{\text{mA}}</math>:</i> Measure mA dc	Same as above (only one range for each input jack position, 30 mA or 1 A)

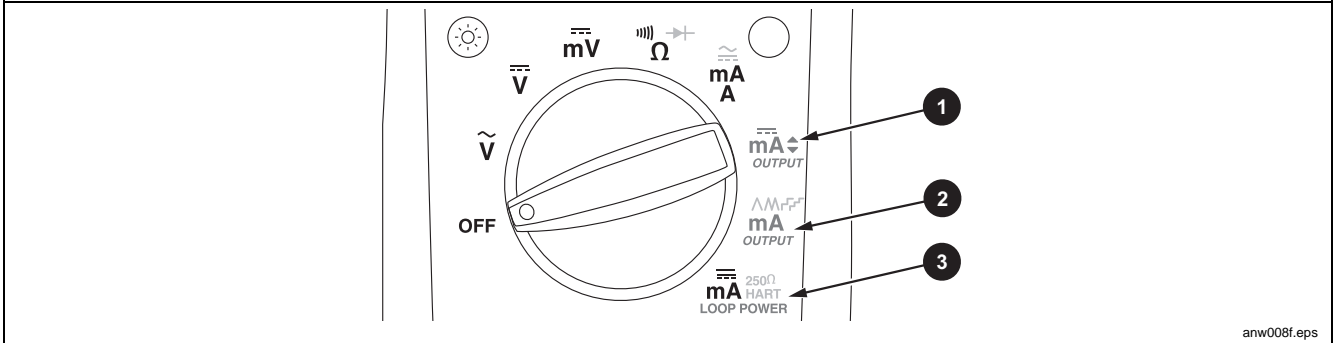

**Table 5. Rotary Function Switch Positions for mA Output**



anw008f.eps

No.	Position	Default Function	Pushbutton Actions
<b>1</b>	<i>OUTPUT</i> $\bar{mA} \rightleftarrows$	<i>Test leads in SOURCE:</i> Source 0 % mA <i>Test leads in SIMULATE:</i> Sink 0 % mA	% STEP ▲ or ▼: Adjusts output up or down to the next 25 % step COARSE ▲ or ▼: Adjusts output up or down 0.1 mA FINE ▲ or ▼: Adjusts output up or down 0.001 mA <div style="display: flex; gap: 10px; margin-top: 5px;"> <span><input type="button" value="0%"/> sets output to 0 %</span> <span><input type="button" value="100%"/> sets output to 100 %</span> </div>

Table 5. Rotary Function Switch Positions for mA Output (cont.)





No.	Position	Default Function	Pushbutton Actions
2	OUTPUT <b>mA</b> 	<i>Test leads in</i> <b>SOURCE:</b> Source repeating 0 % -100 %-0 % slow ramp ( $\wedge$ ) <i>Test leads in</i> <b>SIMULATE:</b> Sink repeating 0 % -100 %-0 % slow ramp ( $\wedge$ )	○ (Blue) cycles through: <ul style="list-style-type: none"> <li>• Fast repeating 0 % -100 % - 0 % ramp (<math>\mathcal{M}</math> on display)</li> <li>• Slow repeating 0 % -100 % - 0 % ramp in 25 % steps (<math>\square</math> on display)</li> <li>• Fast repeating 0 % -100 % - 0 % ramp in 25 % steps (<math>\square</math> on display)</li> <li>• Slow repeating 0 % -100 % - 0 % ramp (<math>\wedge</math> on display)</li> </ul>
3	 (789 only)	<i>Test leads in</i> <b>SOURCE:</b> Supply 24 V loop power, measure mA	○ (Blue) cycles through: <ul style="list-style-type: none"> <li>• 250 <math>\Omega</math> series resistor for HART communication switched in</li> <li>• 250 <math>\Omega</math> series resistor switched out</li> </ul>



**Table 6. Pushbuttons**

	<b>No.</b>	<b>Pushbutton</b>	<b>Function</b>
	<b>1</b>		Set the backlight to low, high, and off
	<b>2</b>	Span Check 	<i>mA Output:</i> Adjusts mA output to 0 % value (4 mA or 0 mA)
	<b>3</b>	 Span Check	<i>mA Output:</i> Sets mA output to 100 % value (20 mA)
	<b>4</b>	 % STEP	<i>Measuring:</i> Selects a MIN, MAX, or AVG action <i>mA Output:</i> Adjusts mA output up to the next higher 25 % step
	<b>5</b>	 COARSE	<i>Measuring:</i> Selects a fixed range (hold for 1 second for auto range) <i>mA Output:</i> Adjusts output up 0.1 mA

Table 6. Pushbuttons (cont.)

No.	Pushbutton	Function
6		<i>Measuring:</i> Toggles AutoHold, or in MIN MAX recording, suspends recording <i>mA Output:</i> Adjusts output up 0.001 mA
7		<i>Measuring:</i> Toggles between frequency counter and voltage measurement functions <i>mA Output:</i> Adjusts output down 0.001 mA
8		Rotary function switch in $\overset{\approx}{mA}$ position and test lead plugged into A $\approx$ jack: Toggles between ac and dc ampere measure Rotary function switch in $\overset{+}{\Omega}$ position: Toggles diode test function ( $\rightarrow $ ) Rotary function switch in <i>OUTPUT mA</i> $\wedge$ $\mathcal{M}$ $\ulcorner$ $\ulcorner$ position: cycles through <ul style="list-style-type: none"> <li>• Slow repeating 0 % -100 % - 0 % ramp (<math>\wedge</math> on display)</li> <li>• Fast repeating 0 % -100 % - 0 % ramp (<math>\mathcal{M}</math> on display)</li> <li>• Slow repeating 0 % -100 % - 0 % ramp in 25 % steps (<math>\ulcorner</math> on display)</li> <li>• Fast repeating 0 % - 100 % - 0 % ramp in 25 % steps (<math>\ulcorner</math> on display)</li> </ul> Rotary function switch in loop supply position (789 only) <ul style="list-style-type: none"> <li>• Switch in/out 250 <math>\Omega</math> series resistor</li> </ul>
9		<i>Measuring:</i> Toggles relative reading (sets a relative zero point) <i>mA Output:</i> Adjusts output down 0.1 mA
10		<i>Measuring:</i> Toggles between $\Omega$ measure and continuity functions <i>mA Output:</i> Adjusts mA output down to the next lower 25 % step



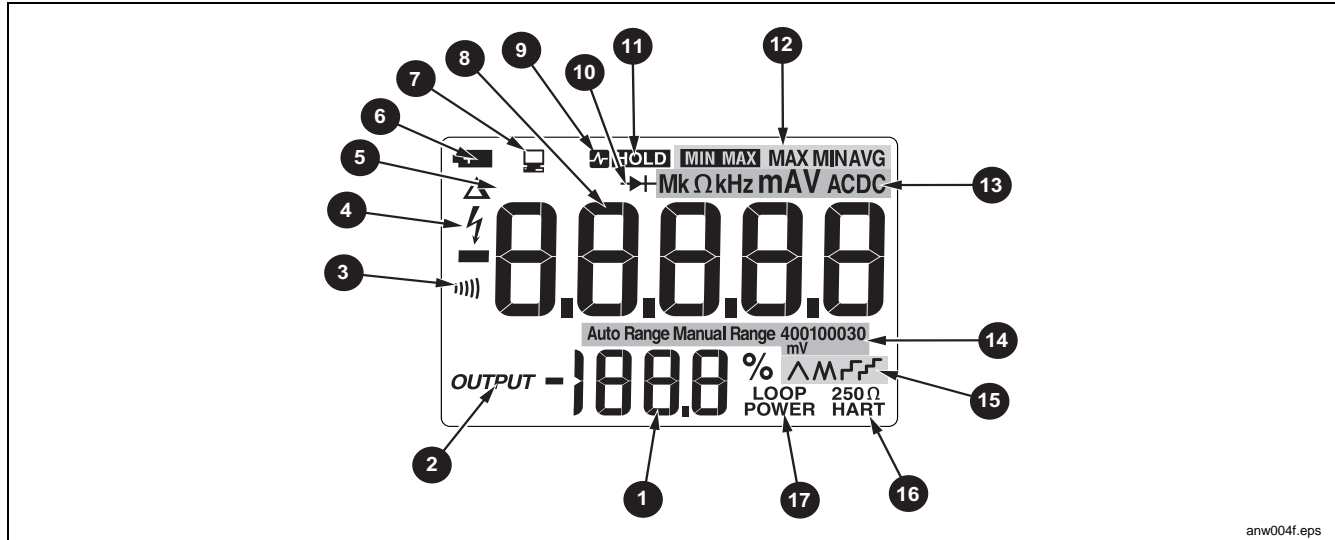







**Table 7. Display**







anw004f.eps

No.	Element	Meaning
1	% (Percentage display)	Shows the mA measured value or output level in %, in a 0-20 mA or 4-20 mA scale (change scales with power-up option)
2	OUTPUT -	Lights when mA output (source or simulate) is active
3	)))	Lights in continuity function

Table 7. Display (cont.)

No.	Element	Meaning
4		Lights when dangerous voltage is detected
5		Lights when relative reading is on
6		Lights when the battery is low
7		Lights when the meter is transmitting or receiving over the IR port
8	Numerals	Show the input or output value
9 11		Lights when AutoHold is on
10		Lights in diode test function
11		Lights when MIN MAX recording is held
12		MIN MAX recording status indicators:  - MIN MAX recording is on MAX - the display is showing the maximum-recorded value MIN - the display is showing the minimum-recorded value AVG - the display is showing the average value
13		Show the input or output units and multipliers associated with the numerals

**Table 7. Display (cont.)**

No.	Element	Meaning
14	<b>Auto Range</b> <b>Manual Range</b>	Range status indicators: <b>Auto Range</b> - autoranging is on <b>Manual Range</b> - the range is fixed
	400100030 mV	The number plus the unit and multiplier indicate the active range.
15		One of these lights in mA ramping or step output (rotary function switch position <b>mA</b> ): <ul style="list-style-type: none"> <li> - slow continuous 0 % - 100 % - 0 % ramping (40 seconds)</li> <li> - fast continuous 0 % - 100 % - 0 % ramping (15 seconds)</li> <li> - slow ramp in 25 % steps (15 seconds/step)</li> <li> - fast ramp in 25 % steps (5 seconds/step)</li> </ul>
16	<b>250 Ω</b> <b>HART</b>	Lights when 250 Ω series resistance is switched in (789 only)
17	<b>Loop Power</b>	Lights when in loop supply mode (789 only)

## Measuring Electrical Parameters

The proper sequence for taking measurements is:

1. Plug the test leads into the appropriate jacks.
2. Set the rotary function switch to the desired function.
3. Touch the probes to the test points.
4. View the results on the LCD display.

### Input Impedance

For the voltage measurement functions, input impedance is 10 M $\Omega$ . See "Specifications" for more information.

### Ranges

A measurement range determines the highest value and resolution at which the meter can measure. Most meter measurement functions have more than one range (see "Specifications").

Make sure the correct range is selected:

- If the range is too low, the display shows **OL** (overload).
- If the range is too high, the meter will not be displaying its most precise measurement.

The meter normally selects the lowest range that will measure the applied input signal (Auto Range showing on the display). Press **RANGE** to lock the range. Each time **RANGE** is pressed, the meter selects the next higher range. At the highest range, it returns to the lowest range.

If the range is locked, the meter resumes auto ranging when it is changed to another measurement function or when **RANGE** is pressed and held for 1 second.

## Testing Diodes

To test a single diode:



1. Insert the red test lead into the  $V \Omega \rightarrow \text{diode symbol}$  jack and black test lead into the COM jack.
2. Set the rotary function switch to  $\text{diode symbol}$ .
3. Press **○** (Blue) so that the  $\rightarrow \text{diode symbol}$  symbol is on the display.
4. Touch the red probe to the anode and the black probe to the cathode (side with band or bands). The meter should indicate the appropriate diode voltage drop.
5. Reverse the probes. The meter displays OL, indicating high impedance.



The diode is good if it passes the tests in steps 4 and 5.

### Displaying Minimum, Maximum, and Average

MIN MAX recording stores the lowest and highest measurements, and maintains the average of all measurements.

Press  to turn on MIN MAX recording. Readings are stored until the meter is turned off, switched to another measurement or source function, or MIN MAX is turned off. The beeper sounds when a new maximum or minimum is recorded. Auto power-off is disabled and auto ranging is turned off during MIN MAX recording.

Press  again to cycle through the MAX, MIN, and AVG displays. Press and hold  for 1 second to erase stored measurements and exit.

In MIN MAX recording, press  to suspend recording; press  again to resume recording.

### Using AutoHold

*Note*

*MIN MAX recording must be off to use AutoHold.*

#### **Warning**

**To avoid possible electric shock, do not use AutoHold to determine if dangerous voltage is present. AutoHold will not capture unstable or noisy readings.**

Activate AutoHold to freeze the meter's display on each new stable reading (except in the frequency counter mode). Press  to activate AutoHold. This feature allows measurements to be taken in situations in which it is difficult to look at the display. The meter beeps and updates the display with each new stable reading.

### **Compensating for Test Lead Resistance**

Use the relative reading feature ( $\Delta$  on the display) to set the present measurement as a relative zero. A common use for this feature is to compensate for test lead resistance when measuring ohms.

Select the  $\Omega$  measure function, touch the test leads together, and then press  $\boxed{\text{REL } \Delta}$ . Until  $\boxed{\text{REL } \Delta}$  is pressed again, or the meter is switched to another measurement or source function, the readings on the display will subtract the lead resistance.

### **Using the Current Output Functions**

The meter provides steady, stepped, and ramped current output for testing 0-20 mA and 4-20 mA current loops. Choose source mode, in which the meter supplies the current, simulate mode, in which the meter regulates

current in an externally powered current loop, or loop supply mode, where the meter powers an external device and measures the loop current.

### **Source Mode**

Source mode is selected automatically by inserting the test leads into the SOURCE + and – jacks as shown in Figure 1. The arrows show the conventional current flow. Use source mode whenever it is necessary to supply current into a passive circuit such as a current loop with no loop supply. Source mode depletes the battery faster than simulate mode, so use simulate mode whenever possible.

The display looks the same in source and simulate modes. The way to tell which mode is in use is to see which pair of output jacks is in use.



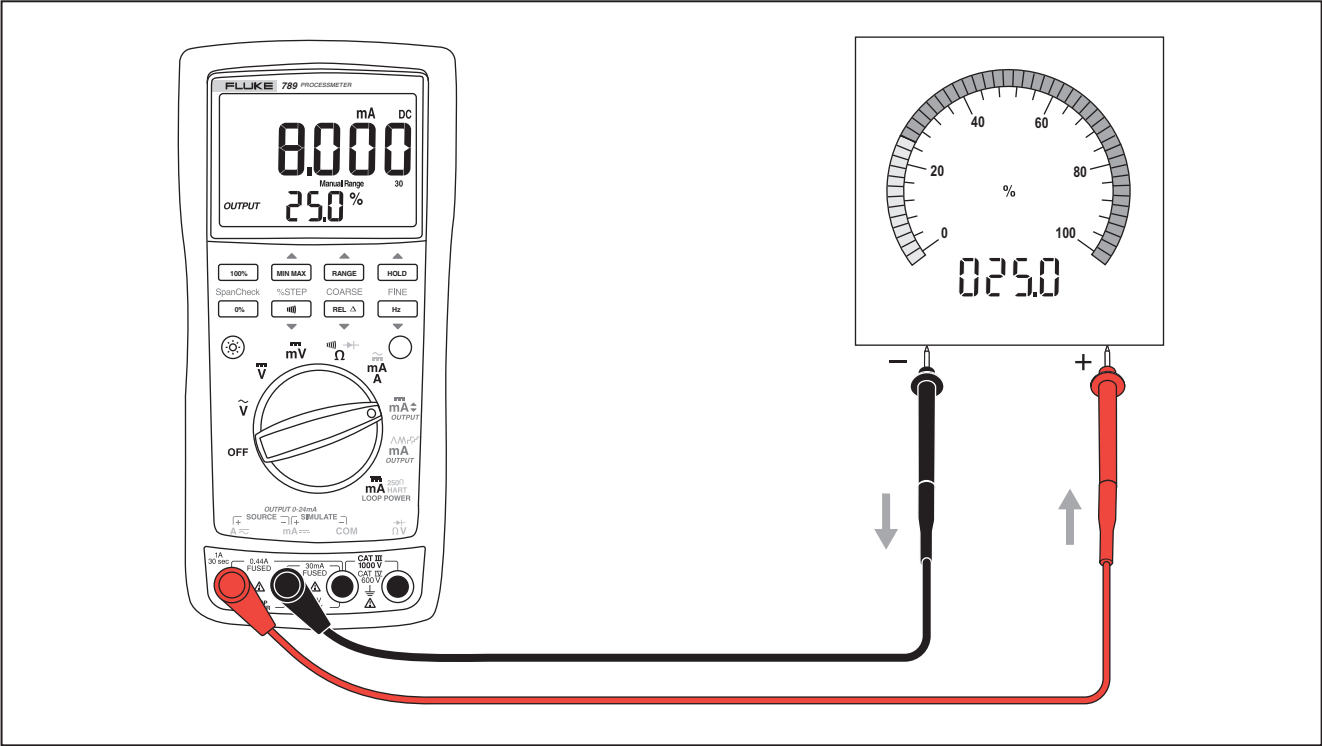

**Figure 1. Sourcing Current**

anw01of.eps

## **Simulate Mode**

Simulate mode is so named because the meter simulates a current loop transmitter. Use simulate mode when an external dc voltage of 15 to 48 V is in series with the current loop under test.

### **⚠ Caution**

**Set the rotary function switch to one of the mA output settings BEFORE connecting the test leads to a current loop. Otherwise, a low impedance from the other rotary function switch positions could be presented to the loop, causing up to 35 mA to flow in the loop.**

Simulate mode is selected automatically by inserting the test leads into the SIMULATE + and – jacks as shown in Figure 2. The arrows show the conventional current flow. Simulate mode conserves battery life, so use it instead of source mode whenever possible.

The display looks the same in source and simulate modes. The way to tell which mode is in use is to see which pair of output jacks is in use.

## **Changing the Current Span**

The meter's current output span has two settings (with overrange to 24 mA):

- 4 mA = 0 %, 20 mA = 100 % (factory default)
- 0 mA = 0 %, 20 mA = 100 %

To find out which span is selected, turn the rotary function switch to OUTPUT mA  $\blacklozenge$ , short the OUTPUT SOURCE + and – jacks, and observe the 0 % output level.

To toggle and save the current output span in nonvolatile memory (retained when the power is turned off):

1. Turn off the meter.
2. Hold down RANGE while turning the meter on.
3. Wait at least 2 seconds until the new range shows as 0-20 or 4-20 and then release RANGE.

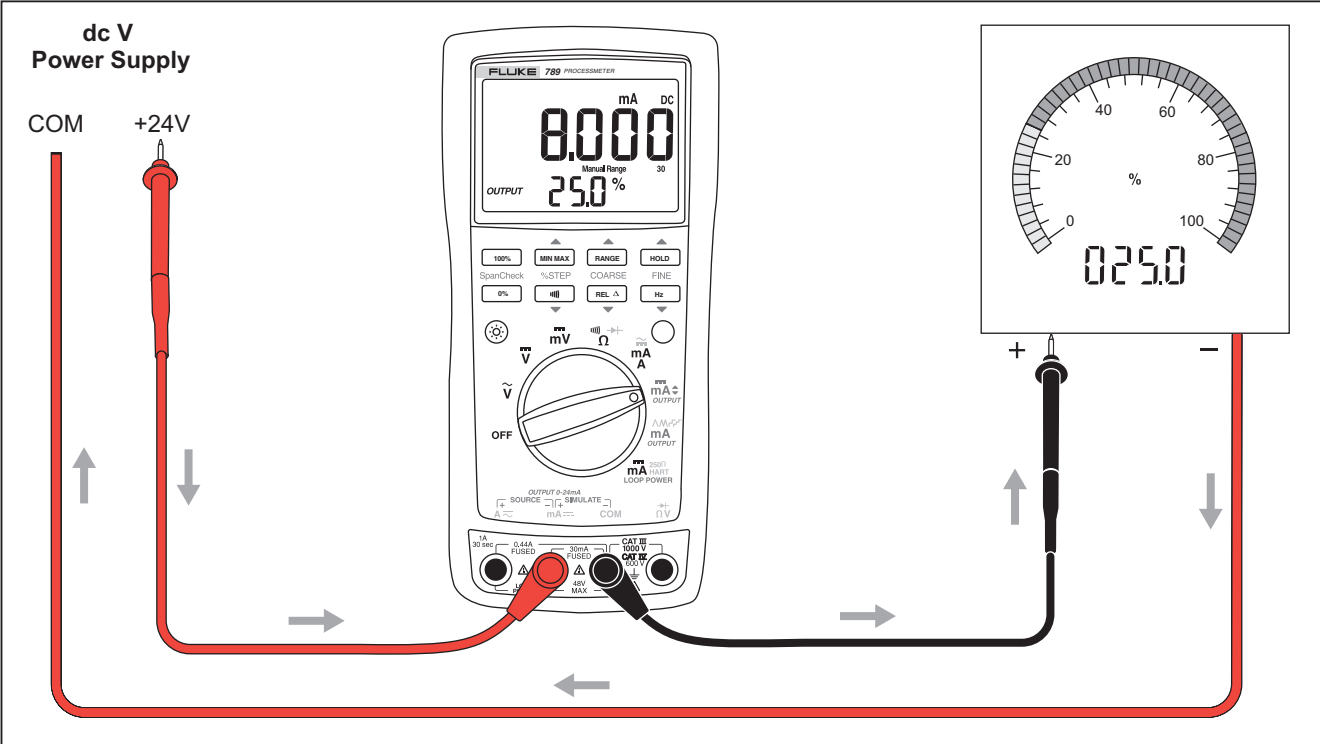

**Figure 2. Simulating a Transmitter**

anw011f.eps

### Producing a Steady mA Output

When the rotary function switch is in the OUTPUT mA  $\blacklozenge$  position, and the OUTPUT jacks are connected to an appropriate load, the meter produces a steady mA dc output. The meter begins sourcing or simulating 0 %. Use the pushbuttons to adjust the current as shown in Table 8.

Select either sourcing or simulating by choosing the SOURCE or SIMULATE output jacks.

If the meter cannot deliver the programmed current because the load resistance is too high or the loop supply voltage is too low, dashes (----) appear on the numeric display. When the impedance between the SOURCE jacks is low enough, the meter will resume sourcing.

*Note*

*The STEP pushbuttons described Table 9 are available when the meter is producing a steady mA output. The STEP pushbuttons go to the next multiple of 25 %.*

**Table 8. mA Output Adjust Pushbuttons**

Pushbutton	Adjustment
<p style="text-align: center;">▲  <span style="border: 1px solid black; padding: 2px;">RANGE</span>                      COARSE</p>	Adjusts up 0.1 mA
<p style="text-align: center;">▲  <span style="border: 1px solid black; padding: 2px;">MIN MAX</span>                      FINE</p>	Adjusts up 0.001 mA
<p style="text-align: center;">FINE  <span style="border: 1px solid black; padding: 2px;">Hz</span>                      ▼</p>	Adjusts down 0.001 mA
<p style="text-align: center;">COARSE  <span style="border: 1px solid black; padding: 2px;">REL Δ</span>                      ▼</p>	Adjusts down 0.1 mA

### Manually Stepping the mA Output

When the rotary function switch is in the OUTPUT mA  $\blacklozenge$  position, and the OUTPUT jacks are connected to an appropriate load, the meter produces a steady mA dc output. The meter begins sourcing or simulating 0 %. Use the pushbuttons to step the current up and down in 25 % increments as shown in Table 9. See Table 10 for mA values at each 25 % step.





Select either sourcing or simulating by choosing the SOURCE or SIMULATE output jacks.

If the meter cannot deliver the programmed current because the load resistance is too high or the loop supply voltage is too low, dashes (----) appear on the numeric display. When the impedance between the SOURCE jacks is low enough, the meter will resume sourcing.

*Note*

*The COARSE and FINE adjustment pushbuttons described in Table 8 are available when manually stepping the mA output.*

**Table 9. mA Stepping Pushbuttons**



Pushbutton	Adjustment
	Adjusts up to the next higher 25 % step
	Adjusts down to the next lower 25 % step
	Sets to 100 % value
	Sets to 0 % value





**Table 10. mA Step Values**

Step	Value (for each span setting)	
	4 to 20 mA	0 to 20 mA
0 %	4.000 mA	0.000 mA
25 %	8.000 mA	5.000 mA
50 %	12.000 mA	10.000 mA
75 %	16.000 mA	15.000 mA
100 %	20.000 mA	20.000 mA
120 %	24.000 mA	24.000 mA
125 %	24.000 mA	

### **Auto Ramping the mA Output**

Auto ramping gives the ability to continuously apply a varying current stimulus from the meter to a transmitter, while hands remain free to test the response of the transmitter. Select either sourcing or simulating by choosing the SOURCE or SIMULATE jacks.

When the rotary function switch is in the OUTPUT **mA**   position, and the output jacks are connected to an appropriate load, the meter produces a continuously repeating 0 % - 100 % - 0 % ramp in a choice of four ramp waveforms:

-  0 % - 100 % - 0 % 40-second smooth ramp (default)
-  0 % - 100 % - 0 % 15-second smooth ramp
-  0 % - 100 % - 0 % Stair-step ramp in 25 % steps, pausing 15 seconds at each step. Steps listed in Table 10.
-  0 % - 100 % - 0 % Stair-step ramp in 25 % steps, pausing 5 seconds at each step. Steps are listed in Table 10.

The ramp times are not adjustable. Press  (Blue) to cycle through the four waveforms.

#### *Note*

*At any time during auto ramping, the ramp can be frozen simply by moving the rotary function switch to the mA  position. Then the COARSE, FINE, and % STEP adjust pushbuttons can be used to make adjustments.*









### **Power-Up Options**

To select a power-up option:

1. Push and hold the pushbutton shown in Table 11.
2. Turn the rotary function switch from OFF to the position listed in Table 11.
3. Wait 2 seconds before you release the pushbutton after powering up the Meter.

The setting for current span, backlight, and beeper is retained when the power is turned off. You must repeat the other options for each operating session.

**Table 11. Power-Up Options**

Option	Button	Switch Position	Default	Display	Action Taken
Current Span		All	Retains setting	0 - 20 or 4 - 20	Toggles between 0-20 mA and 4-20 mA range
Backlight Timeout		All	Retains setting	L on / L off	Enables/Disables the auto-off on backlight after 2 minutes
Beeper		All	Retains setting	b on / b off	Enables/Disables beeper
Auto Power-Off <i>Note: Auto power-off is always disabled when MIN MAX recording is on.</i>	 (Blue)	All	Enabled	PoFF	Disables the feature that turns off the power after 30 minutes of inactivity.
LCD segments		VAC, mA, Source, Ramp, Loop	Disabled	All segments	Display HOLD (as long as button pushed)
Firmware version		VDC	Disabled	ex: 2.0	Display firmware version (as long as button is pushed)
Model number		mVDC	Disabled	ex: 789	Display model number (as long as button is pushed)
Go to Calibration mode		Ω	Disabled	[CAL	Calibration mode starts

### **Loop Power Supply Mode (789 only)**

The Loop Power Supply Mode can be used for powering up a process instrument (transmitter). While in Loop Power Mode, the meter acts like a battery. The process instrument regulates the current. At the same time, the meter measures the current that the process instrument is drawing.

The meter supplies loop power at a nominal 24 V dc. An internal series resistance of 250  $\Omega$  can be switched in for communication with HART and other smart devices by pressing  $\bigcirc$  (Blue). See Figure 3. Pressing  $\bigcirc$  (Blue) again switches out this internal resistance.

When loop power is enabled, the meter is configured to measure mA and >24 V dc is sourced between the mA and A jacks. The mA jack is the common and the A jack is at >24 V dc. Connect the meter in series with the instrument current loop. See Figure 4.

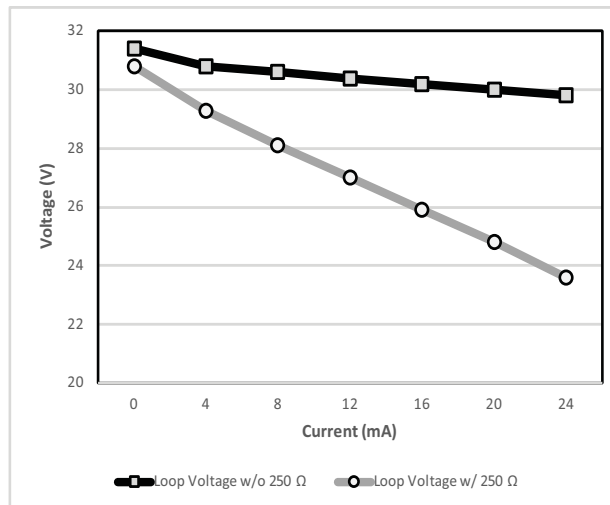

**Figure 3. Loop Power Voltage vs. Current**

anw02of.eps



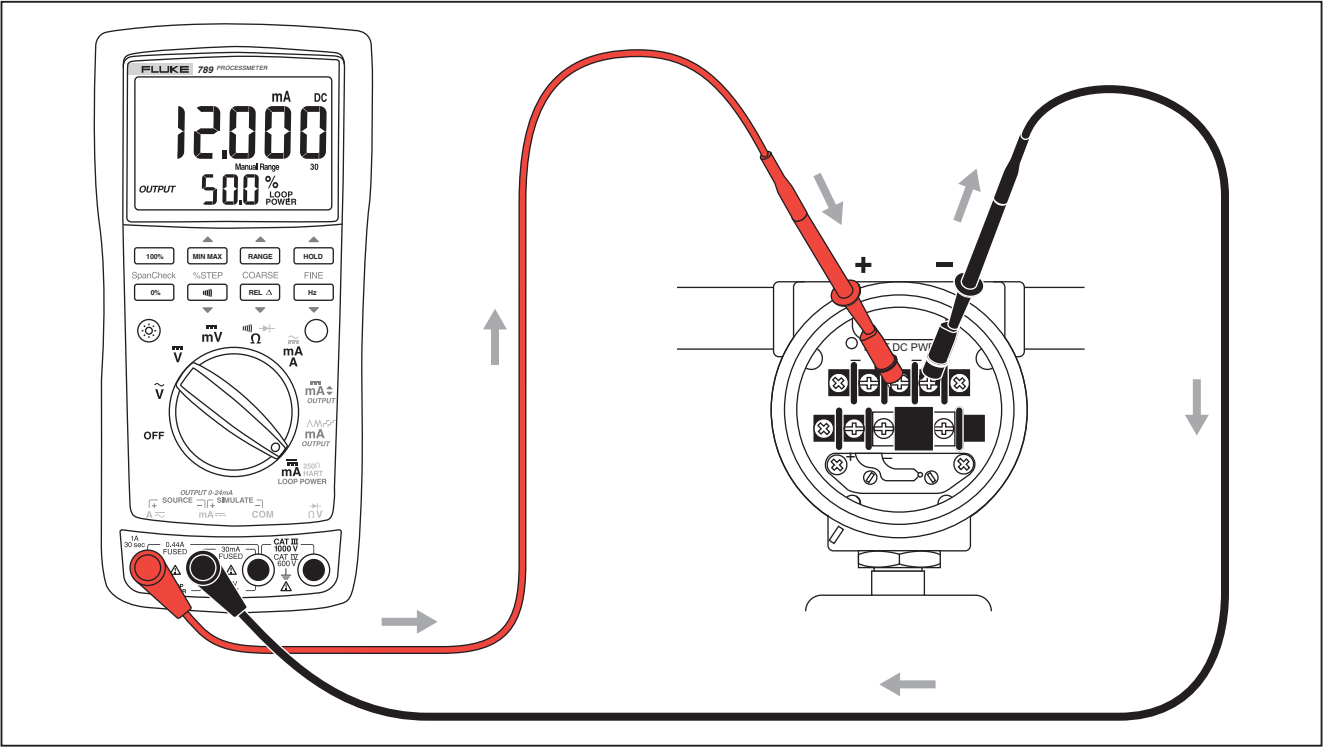

**Figure 4. Connections for Supplying Loop Power**

anw009f.eps

## Battery Life

### Warning

To avoid false readings, which could lead to possible electric shock or personal injury, replace the battery as soon as the battery indicator (🔋) appears.

Table 12 shows typical alkaline battery life. To preserve battery life:

- Use current simulation instead of sourcing when possible.
- Avoid using the backlight.
- Do not disable the automatic power-off feature.
- Turn the meter off when not in use.

Table 12. Typical Alkaline Battery Life

Meter Operation	Hours
Measuring any parameter	140
Simulating Current	140
Sourcing 12 mA into 500 $\Omega$	10

## Maintenance

This section provides some basic maintenance procedures. Repair, calibration, and servicing not covered in this manual must be performed by qualified personnel. For maintenance procedures not described in this manual, contact a Fluke Service Center.

Periodically wipe the case with a damp cloth and detergent; do not use abrasives or solvents.

### Warning

To prevent possible electrical shock, fire, or personal injury:

- Do not put battery cells and battery packs near heat or fire. Do not put in sunlight.
- Replace a blown fuse with exact replacement only for continued protection against arc flash.
- Do not operate the Product with covers removed or the case open. Hazardous voltage exposure is possible.
- Use only specified replacement parts.
- Use only specified replacement fuses.
- Have an approved technician repair the Product.

### **Calibration**

Calibrate the meter once a year to ensure that it performs according to its specifications. Contact a Fluke Service Center for instructions.

### **Replacing the Batteries**

#### **⚠ Warning**

**For safe operation and maintenance, repair the Product before use if the battery leaks.**

To replace the batteries:

1. Remove the test leads and turn the Meter OFF. See Figure 5.
2. With a standard blade hand screwdriver, turn each battery door screw counterclockwise so that the slot is parallel with the screw picture molded into the case.
3. Lift off the battery door.
4. Remove the meter's batteries.
5. Replace with four new AA alkaline batteries.
6. Reinstall the battery door and tighten screws.

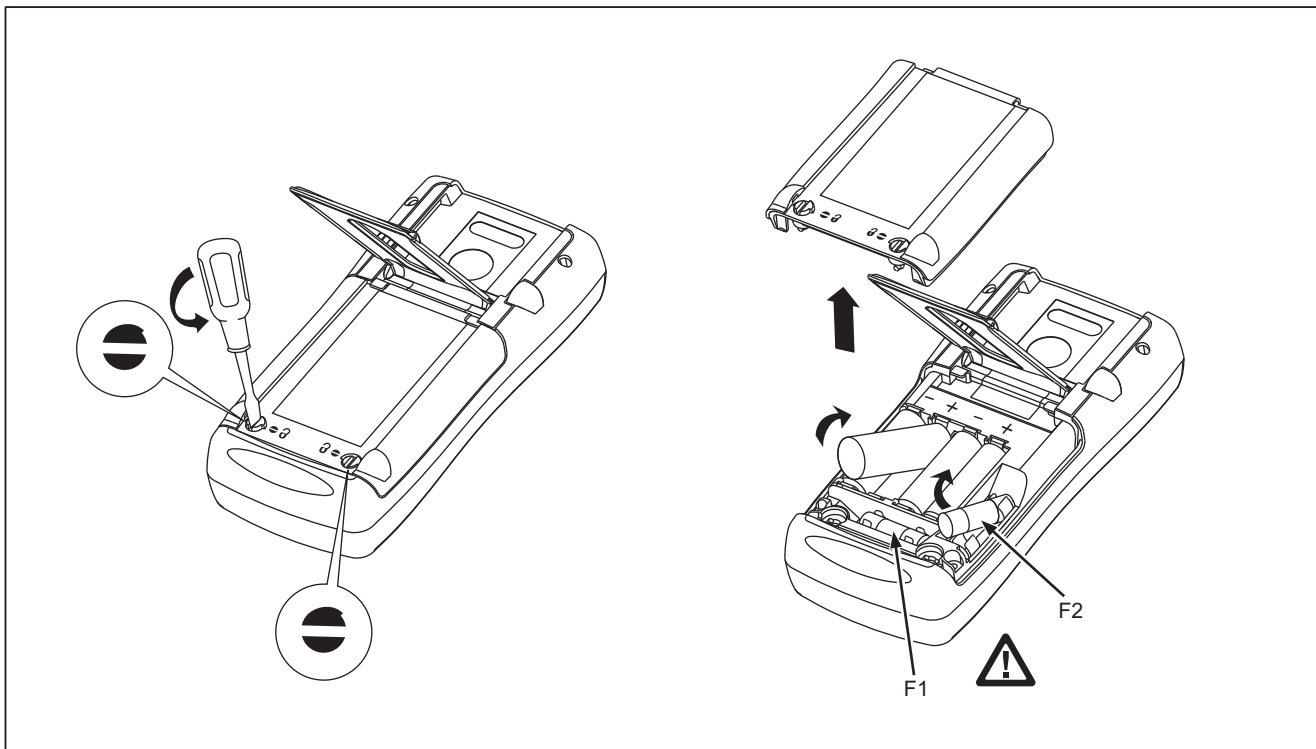

Figure 5. Replacing the Batteries and Fuses

anw037.eps

## Replacing a Fuse

### Warning

**To avoid personal injury or damage to the meter, use only the specified replacement fuse, 440 mA 1000 V fast-blow, Fluke PN 943121.**

Both current input jacks are fused with separate 440 mA fuses. To determine if a fuse is blown:

1. Turn the rotary function switch to  $\frac{mA}{A}$ .
2. Plug the black test lead into COM, and the red test lead into the **A**  $\sim$  input.
3. Using an ohmmeter, check the resistance between the meter test leads. If the resistance is about 1  $\Omega$ , the fuse is good. An open reading means that fuse F2 is blown.
4. Move red test lead to **mA**.
5. Using an ohmmeter, check the resistance between the meter test leads. If the resistance is about 14  $\Omega$ , the fuse is good. An open means that fuse F1 is blown.

If a fuse is blown, replace it as follows. Refer to Figure 6 as necessary:

1. Remove the test leads from the meter and turn the meter OFF.
2. With a standard blade hand screwdriver, turn each battery door screw counterclockwise so that the slot is parallel with the screw picture molded into the case.
3. Remove either fuse by gently prying one end loose, then sliding the fuse out of its bracket.
4. Replace the blown fuse(s).
5. Replace the battery access door. Secure the door by turning the screws one-quarter turn clockwise.

***If the Meter does not Work***

- Examine the case for physical damage. If there is damage, make no further attempt to use the meter, and contact a Fluke Service Center.
- Check the battery, fuses, and test leads.
- Review this manual to make sure you are using the correct jacks and rotary function switch position.

If the meter still does not work, contact a Fluke Service Center. If the meter is under warranty, it will be repaired or replaced (at Fluke's option) and returned at no charge. See the Warranty on the back of the title page for terms. If the warranty has lapsed, the meter will be repaired and returned for a fixed fee. Contact a Fluke Service Center for information and price.

***Replacement Parts and Accessories*****⚠ Warning**

**To avoid personal injury or damage to the meter, use only the specified replacement fuse, 440 mA 1000 V fast-blow, Fluke PN 943121.**

*Note*

*When servicing the meter, use only the replacement parts specified here.*

Replacement parts and some accessories are shown in Figure 6 and listed in Table 13. Many more DMM accessories are available from Fluke. For a catalog, contact the nearest Fluke distributor.

To find out how to order parts or accessories use the telephone numbers or addresses in *How to Contact Fluke*.

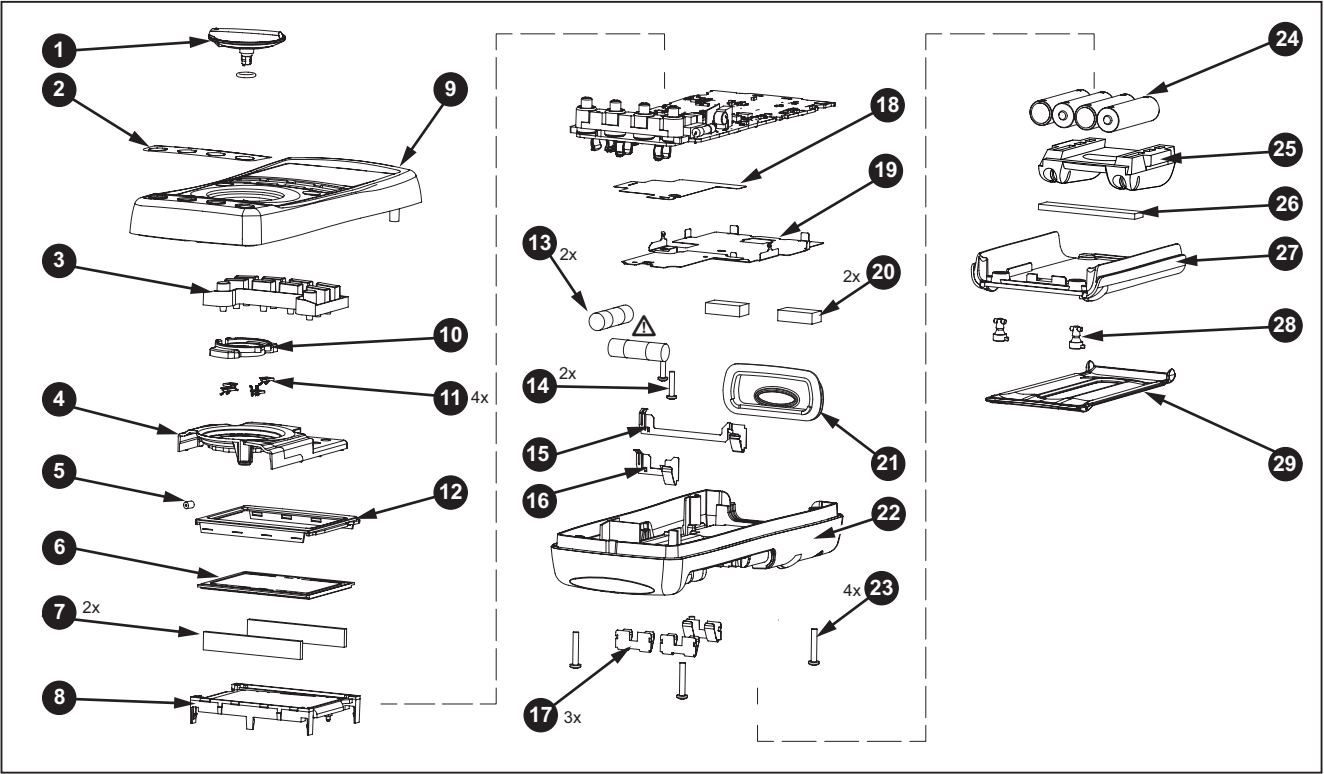

Figure 6. Replacement Parts

anw038.eps

Table 13. Replacement Parts

Item Number	Description	Fluke PN for 789	Fluke PN for 787B	Quantity
①	Knob Assembly with o-ring	658440	4772670	1
②	Decal, Top Case	1623923	4772201	1
③	Keypad	1622951		1
④	Top Shield	4772681		1
⑤	Top Shield Contact	674853		1
⑥	LCD Display	1883431		1
⑦	LCD Connectors, Elastomeric	1641965		2
⑧	Backlight/Bracket	4756199		1
⑨	Top Case with Lens Protector	1622855	4772197	1
⑩	Contact Housing	1622913		1
⑪	RSOB Contact	1567683		4
⑫	Mask	1622881	4772655	1
⑬	⚠ Fuse, 440 mA, 1000 V fast-blow	943121		2
⑭	PCB Screw	832220		2
⑮	Battery Contact, Negative	658382		1
⑯	Battery Contact, Positive	666438		1
⑰	Battery Contacts Dual	666435		3



**Table 13. Replacement Parts (cont.)**

Item Number	Description	Fluke PN for 789	Fluke PN for 787B	Quantity
18	Bottom Insulator	4811256		1
19	Bottom Shield	1675171		1
20	Shock Absorber	878983		1
21	IR Lens	658697		1
22	Bottom Case	659042	4772662	1
23	Case Screws	1558745		4
24	Battery, 1.5 V, 0-15 mA, AA Alkaline	376756		4
25	Accessory Mount with Probe Holders	658424		1
26	Shock Absorber	674850		1
27	Access Door, Battery/Fuse	1622870		1
28	Fasteners, Battery/Fuse Access Door	948609		2
29	Tilt-Stand	659026		1
-	Test Leads	variable <sup>[1]</sup>		1 (set of 2)
-	Alligator Clips	variable <sup>[1]</sup>		1 (set of 2)
[1] See <a href="http://www.fluke.com">www.fluke.com</a> for more information about the test leads and alligator clips available for your region.				

## Specifications

All specifications apply from +18 °C to +28 °C unless stated otherwise.

All specifications assume a 5-minute warm-up period.

The standard specification interval is 1 year.

### Note

“Counts” refers to the number of increments or decrements of the least significant digit.

## DC Volts Measurement

Range (V dc)	Resolution	Accuracy, $\pm$ (% of Reading + Counts)
4.000	0.001 V	0.1 % + 1
40.00	0.01 V	0.1 % + 1
400.0	0.1 V	0.1 % + 1
1000	1 V	0.1 % + 1

Input impedance: 10 M $\Omega$  (nominal), < 100 pF  
 Normal mode rejection ratio: > 60 dB at 50 Hz or 60 Hz  
 Common mode rejection ratio: > 120 dB at dc, 50 Hz, or 60 Hz  
 Overvoltage protection: 1000 V

**DC Millivolts Measurement**

Range (mV dc)	Resolution	Accuracy, $\pm$ (% of Reading + Counts)
400.0	0.1 mV	0.1 % + 2

**AC Volts Measurement**

Range (ac)	Resolution	Accuracy, $\pm$ (% of Reading + Counts)		
		50 Hz to 60 Hz	45 Hz to 200 Hz	200 Hz to 500 Hz
400.0 mV	0.1 mV	0.7 % + 4	1.2 % + 4	7.0 % + 4
4.000 V	0.001 V	0.7 % + 2	1.2 % + 4	7.0 % + 4
40.00 V	0.01 V	0.7 % + 2	1.2 % + 4	7.0 % + 4
400.0 V	0.1 V	0.7 % + 2	1.2 % + 4	7.0 % + 4
1000 V	1 V	0.7 % + 2	1.2 % + 4	7.0 % + 4

*Specifications are valid from 5 % to 100 % of amplitude range.*

*AC conversion: true rms*

*Maximum crest factor: 3 (between 50 and 60 Hz)*

*For non-sinusoidal waveforms, add  $\pm$ (2 % reading + 2 % f.s.) typical*

*Input impedance: 10 M $\Omega$  (nominal), < 100 pF, ac-coupled*

*Common mode rejection ratio: > 60 dB at dc, 50 Hz, or 60 Hz*

**AC Current Measurement**

Range 45 Hz to 2 kHz	Resolution	Accuracy, $\pm$ (% of Reading + Counts)	Typical Burden Voltage
1.000 A (Note)	0.001 A	1 % + 2	1.5 V/A
<i>Note: 440 mA continuous, 1 A 30 seconds maximum</i>			
<i>Specifications are valid from 5 % to 100 % of amplitude range.</i>			
<i>AC conversion: true rms</i>			
<i>Maximum crest factor: 3 (between 50 and 60 Hz)</i>			
<i>For non-sinusoidal waveforms, add <math>\pm</math>( 2 % reading + 2 % f.s.) typical</i>			
<i>Overload protection 440 mA, 1000 V fast-blow fuse</i>			

**DC Current Measurement**

Range	Resolution	Accuracy, $\pm$ (% of Reading + Counts)	Typical Burden Voltage
30.000 mA	0.001 mA	0.05 % + 2	14 mV/mA
1.000 A (Note)	0.001 A	0.2 % + 2	1.5 V/A
<i>Note: 440 mA continuous, 1 A 30 seconds maximum</i>			
<i>Overload protection: 440 mA, 1000 V fast-blow fuse</i>			

**Ohms Measurement**

Range	Resolution	Measurement Current	Accuracy, $\pm$ (% of Reading + Counts)
400.0 $\Omega$	0.1 $\Omega$	310 $\mu$ A	0.2 % + 2
4.000 k $\Omega$	0.001 k $\Omega$	31 $\mu$ A	0.2 % + 1
40.00 k $\Omega$	0.01 k $\Omega$	2.5 $\mu$ A	0.2 % + 1
400.0 k $\Omega$	0.1 k $\Omega$	250 nA	0.2 % + 1
4.000 M $\Omega$	0.001 M $\Omega$	250 nA	0.35 % + 3
40.00 M $\Omega$	0.01 M $\Omega$	125 nA	2.5 % + 3
<i>Overload protection: 1000 V</i> <i>Open circuit voltage: &lt;3.9 V</i>			

**Frequency Counter Accuracy**

Range	Resolution	Accuracy, $\pm$ (% of Reading + Counts)
199.99 Hz	0.01 Hz	0.005 % + 1
1999.9 Hz	0.1 Hz	0.005 % + 1
19.999 kHz	0.001 kHz	0.005 % + 1

*Display updates 3 times/second at > 10 Hz*

**Frequency Counter Sensitivity**

Input Range	Minimum Sensitivity (rms Sinewave) 5 Hz to 5 kHz*	
	AC	DC (approximate trigger level 5 % of full scale)
400 mV	150 mV (50 Hz to 5 kHz)	150 mV
4 V	1 V	1 V
40 V	4 V	4 V
400 V	40 V	40 V
1000 V	400 V	400 V

\*Usable 0.5 Hz to 20 kHz with reduced sensitivity.  
10<sup>6</sup> VHz max

**Diode Test and Continuity Test**

- Diode test indication .....Displays voltage drop across device, 2.0 V full scale. Nominal test current 0.3 mA at 0.6 V. Accuracy  $\pm(2\% + 1 \text{ count})$ .
- Continuity test indication .....Continuous audible tone for test resistance  $<100 \Omega$
- Open circuit voltage.....2.9 V
- Short circuit current .....310  $\mu\text{A}$  typical
- Overload protection .....1000 V rms

**Loop Power Supply Voltage** .....24 V, Short Circuit protected

**DC Current Output**

Source mode

- Span .....0 mA or 4 mA to 20 mA, with overrange to 24 mA
- Accuracy.....0.05 % of span
- Compliance voltage.....28 V with battery voltage  $>\sim 4.5 \text{ V}$

Simulate Mode

- Span .....0 mA or 4 mA to 20 mA, with overrange to 24 mA
- Accuracy.....0.05 % of span
- Loop voltage.....24 V nominal, 48 V maximum, 15 V minimum
- Compliance voltage.....21 V for 24 V supply
- Burden voltage ..... $<3 \text{ V}$

**General Specifications****Maximum Voltage between**

any Terminal and Earth Ground..... 1000 V

**Fuse Protection for**

mA inputs..... 0.44 A, 1000 V, IR 10 kA

**Power**

Battery Type..... IEC LR6 (AA Alkaline)

Quantity..... 4

**Temperature**

Operating..... -20 °C to +55 °C

Storage..... -40 °C to +60 °C

**Altitude**

Operating..... ≤2000 m

Storage..... ≤12 000 m

**Frequency Overload Protection**..... 10<sup>6</sup> V Hz max**Temperature coefficient**

Measurements..... 0.05 x specified accuracy per °C for temperatures &lt;18 °C or &gt;28 °C

Source..... 0.1 x specified accuracy per °C for temperatures &lt;18 °C or &gt;28 °C

**Relative humidity**..... 95 % up to 30 °C, 75 % up to 40 °C, 45 % up to 50 °C, and 35 % up to 55 °C**Size**..... 10.0 cm X 20.3 cm X 5.0 cm (3.94 in X 8.00 in X 1.97 in)**Weight**..... 610 g (1.6 lb)**Safety**

General..... IEC 61010-1: Pollution Degree 2

Measurement..... IEC 61010-2-033: CAT IV 600 V / CAT III 1000 V



<b>Electromagnetic Compatibility (EMC)</b> .....	Accuracy for all ProcessMeter functions is not specified in RF field >3 V/m
International.....	IEC 61326-1: Portable Electromagnetic Environment; IEC 61326-2-2 CISPR 11: Group 1, Class A <i>Group 1: Equipment has intentionally generated and/or uses conductively-coupled radio frequency energy that is necessary for the internal function of the equipment itself.</i> <i>Class A: Equipment is suitable for use in all establishments other than domestic and those directly connected to a low-voltage power supply network that supplies buildings used for domestic purposes. There may be potential difficulties in ensuring electromagnetic compatibility in other environments due to conducted and radiated disturbances.</i> <i>Caution: This equipment is not intended for use in residential environments and may not provide adequate protection to radio reception in such environments.</i> <i>Emissions that exceed the levels required by CISPR 11 can occur when the equipment is connected to a test object.</i>
Korea (KCC).....	Class A Equipment (Industrial Broadcasting & Communication Equipment) <i>Class A: Equipment meets requirements for industrial electromagnetic wave equipment and the seller or user should take notice of it. This equipment is intended for use in business environments and not to be used in homes.</i>
USA (FCC) .....	47 CFR 15 subpart B. This product is considered an exempt device per clause 15.103.

